

AN IMPROVED VOLTAGE MODEL BASED ON STATOR RESISTANCE ESTIMATION FOR FOC TECHNIQUE IN THE INDUCTION MOTOR DRIVE

Bach Hoang DINH¹ , Cuong Dinh TRAN¹ 

¹Power System Optimization Research Group, Faculty of Electrical and Electronics Engineering, Ton Duc Thang University, 19 Nguyen Huu Tho, District 7, Ho Chi Minh City, Vietnam

dinhhoangbach@tdtu.edu.vn, trandinhcuong@tdtu.edu.vn

DOI: 10.15598/aece.v22i2.5745

Article history: Received Feb 08, 2024; Revised Apr 02, 2024; Accepted May 06, 2024; Published Jun 30, 2024.
This is an open access article under the BY-CC license.

Abstract. *The paper presents an improvement in estimating the rotor flux angle using the voltage model of the field-oriented control (FOC) technique in the induction motor speed control. The voltage model uses the inputs including the stator voltage and current signals to estimate the rotor flux angle for FOC method. However, the inaccuracy of the stator resistance value can affect the estimation of the rotor flux angle, leading to a decline in the performance of the control method. An adaptive tuning method based on the machine model is used to estimate the stator resistance to enhance the accuracy of the rotor flux angle in the FOC method. Simulations of the induction motor drive (IMD) operating in the case of stator resistance changing will be performed to verify the effectiveness of the proposed method.*

Keywords

Field-oriented control, induction motor, rotor flux, stator current, voltage model.

1. Introduction

Today, most of the conversion of electrical energy into mechanical energy is employed through the transformation of the actual drive, with the electric motor playing a central role. Most electric motors operate based on electromagnetic interaction to provide the electrical torque on the motor shaft. Electric motors can be divided into three main groups: DC motors, synchronous motors, and induction motors. DC motors have the

advantage of large torque and easy speed control, but their commutator structure generates loud noise and fire sparks during operation [1, 2]. Synchronous motors have the advantage of speed being stable and consistent with the electrical source frequency; however, the configuration is complex [3, 4], and the cost is high, especially the synchronous motors using permanent magnets being sensitive to high temperature. With the advantages of size, performance, and durability, three-phase induction motors are the industry's most widely used type of motor [5, 6]. Corresponding to the strong development of power electronics technology, modern control algorithms are increasingly widely applied in the speed control of IMDs. Control algorithms based on appropriate hardware configuration are used for various control requirements, mainly including two branches: scalar control (SC) and vector control (VC). SC is primarily applied to applications that require medium-level precision speed control [7, 8]. In contrast, FOC, a typical method belonging to the VC group, is preferred for use in applications requiring high precision [9, 10]. This study's objective focuses on improving the performance of the FOC method in precise speed control.

The process of controlling the speed of the motor is the result of electromagnetic interaction to generate an appropriate electric torque to the load torque at the operation point. The electric torque is determined through the combination of magnetic field and electric current factors according to the particular characteristics of each motor type. In separately excited DC motors, torque control can be performed simply due to the independence between the magnetic field and armature current on the rotor. On the contrary,

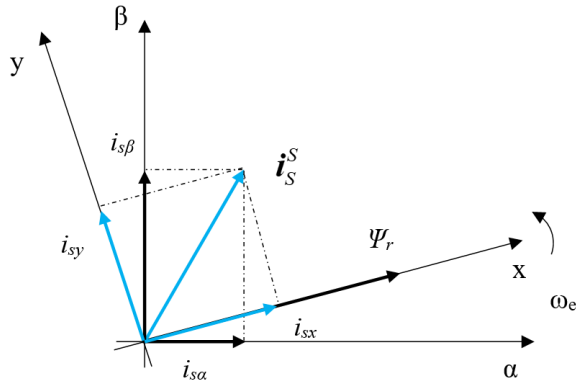

Fig. 1: Current space vector separation in the FOC technique.

the electromagnetic relationship in an IM is nonlinear; hence, the typical methods make it difficult to control the electromagnetic quantities independently. To overcome the control complexity due to the nonlinear configuration of IM, space vector control techniques, typically the FOC method, are researched and applied to speed control applications. The FOC method based on the space current vector pretends to the principle of separate excited DC motors to control the flux and torque-current factors independently [11,12]. The FOC method converts stator currents in the real-time domain into current space vectors based on Clarke and Park transformations [13,14].

The current space vector is decomposed into two perpendicular components, including the x-axis component coincident with the rotor flux vector to maintain the rated value of the flux and the y-axis component to adapt the electrical torque [15,16], shown in Fig. 1. According to the principle of the FOC technique, the rotor flux angle plays a core role in orienting the current space vector during motor speed control. Two main methods for determining the rotor flux angle are direct field-oriented control (DFOC) and indirect field-oriented control (IFOC). DFOC uses sensors to measure the magnetic flux vector position, while IFOC uses estimation techniques to determine the magnetic flux position [17,18]. Due to cost, structure, and performance advantages, the IFOC group is the preferred choice in applying FOC control techniques. Two main types of models are mainly used for rotor flux estimation, including a current model and a voltage model [19–21]. In [22,23], the current model, which is sensitive to the rotor resistance parameter [24,25], uses the stator current and rotor speed signals to determine the rotor flux angle. In contrast, the voltage model, which is sensitive to the stator resistance parameter [26,27], uses the voltage and current signals for the rotor flux estimation [28].

Remark 1: During operation, the temperature motor will increase high, directly affecting the resistance value, while the inductances are mainly affected by the

structure and material that is less affected directly by temperature, so it can be ignored in the estimation.

This research proposes an improved voltage model in the FOC method by integrating stator resistance tuning into the rotor flux estimation. The content of the proposed method is described in the second part. In the third part, the operations of IMD based on the FOC method are simulated in the Matlab/Simulink, and the performance of the proposed method is evaluated through the Integral time absolute error (ITAE) index [29]. Conclusions and discussions for future research are presented in the final part.

2. Proposed FOC Method Applied Voltage Model Integrating Stator Resistance Tuning

Part two includes the general control structure of the drive system applying the FOC control technique for speed control, the axis transformation methods used for space vector, and the rotor flux estimation method in the voltage model.

2.1. The field-oriented control (FOC) structure in the IMD

The general structure of a motor drive that applies inverter technology to control speed includes four main parts: motor connecting load, controller, inverter, and sensors, as shown in Fig. 2. Depending on various techniques, the controller generates pulses to switch the inverter to provide voltage to the motor to meet control requirements.

In the FOC technique, the controller will transform electrical quantities in the time domain into space vectors in the stationary coordinate system $[\alpha\beta]$ and rotating coordinate $[xy]$. The transformations of the space vector from the time domain to stationary and rotating coordinates follow the Clarke transformation in Eq. (1) and the Park transformation in Eq. (2)

$$\begin{bmatrix} X_\alpha \\ X_\beta \end{bmatrix} = \begin{bmatrix} 1 & 0 \\ \frac{1}{\sqrt{3}} & \frac{2}{\sqrt{3}} \end{bmatrix} \cdot \begin{bmatrix} X_a \\ X_b \end{bmatrix}, \quad (1)$$

$$\begin{bmatrix} X_x \\ X_y \end{bmatrix} = \begin{bmatrix} \cos \gamma & \sin \gamma \\ -\sin \gamma & \cos \gamma \end{bmatrix} \cdot \begin{bmatrix} X_\alpha \\ X_\beta \end{bmatrix}, \quad (2)$$

With: " γ ": rotor flux angle, the " X_i " components of the electrical quantities, including voltage and current, according to coordinate systems. The FOC method uses the rotating coordinate system $[xy]$ to separate the stator current into two perpendicular components,

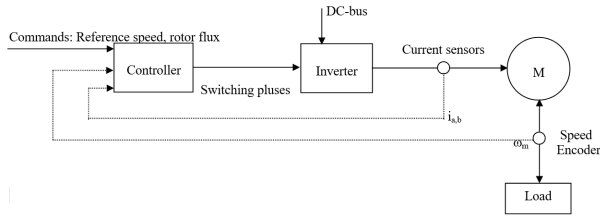

Fig. 2: Control structure of the IMD.

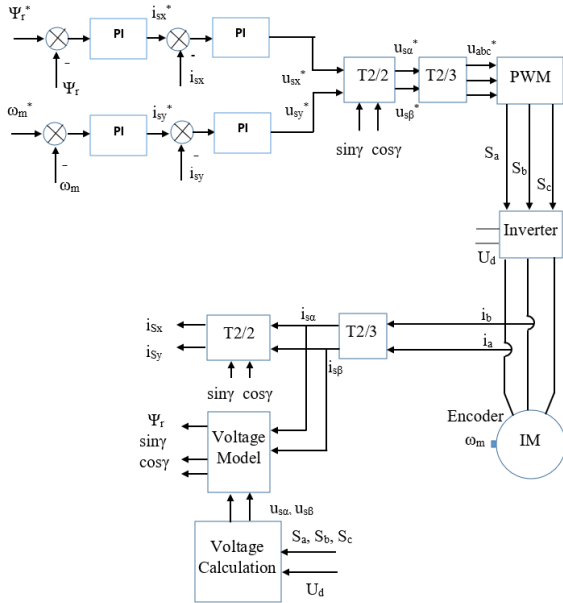

Fig. 3: FOC structure in the IMD.

" i_{sx} " is used to control the rotor flux, " i_{sy} " corresponds to the electric torque component for controlling the motor speed. The structure of the FOC method in the form of a block diagram is presented in Fig. 3.

2.2. Proposed voltage model integrating resistance tuning

The voltage model receives current and voltage quantities as the inputs to estimate the rotor flux vector, where the voltage signal is modulated from the switching pulses and voltage DC-link according to [30]. The components of the rotor flux vector in the $[\alpha\beta]$ coordinate system is estimated as Eq. (3), Eq. (4). The magnitude and angle of the rotor flux vector can be

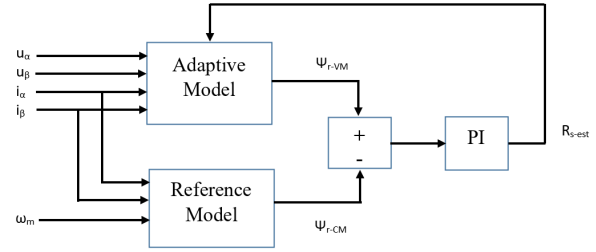

Fig. 4: The stator resistance estimation based on MRAS.

determined by Eq. (5), Eq. (6).

$$\psi_{r\alpha}^{VM} = \frac{L_r}{L_m} \left[\int (u_{s\alpha} - R_s i_{s\alpha}) dt - \frac{L_s L_r - L_m^2}{L_r} i_{s\alpha} \right], \quad (3)$$

$$\psi_{r\beta}^{VM} = \frac{L_r}{L_m} \left[\int (u_{s\beta} - R_s i_{s\beta}) dt - \frac{L_s L_r - L_m^2}{L_r} i_{s\beta} \right], \quad (4)$$

$$\psi_r = \psi_{r-VM} = \sqrt{(\psi_{r\alpha}^{VM})^2 + (\psi_{r\beta}^{VM})^2}, \quad (5)$$

$$\gamma = \arctg \left(\frac{\psi_{r\beta}^{VM}}{\psi_{r\alpha}^{VM}} \right). \quad (6)$$

In (3,4), the motor parameters: $L_s/L_r/L_m$ are stator/rotor/magnetizing inductances, and " R_s " is stator resistance. Inductance parameters change little and are almost stable during operation, while resistance parameters due to material factors will vary due to the influence of temperature during operating conditions.

The parameter " R_s " is estimated using the Model Reference Adaptive System (MRAS) technique to increase the accuracy of the rotor flux estimation method using the voltage model. The MRAS includes two models: a reference model and an adaptive model; these two models are used to generate the same type of signal, and then the comparison algorithm is applied to determine deviation for estimating the required parameters. The Block structure based on the MRAS technique is shown in Fig. 4.

The voltage model is used as the Adaptive model by replacing " R_s " in Eq. (3) and Eq. (4) with " R_{s-est} ".

The current model is used as the Reference model to calculate the rotor flux, as in Eq. (7), Eq. (8), Eq. (9).

$$\psi_{r\alpha}^{CM} = \int \left[\frac{L_m}{T_r} i_{s\alpha} - \frac{1}{T_r} \psi_{r\alpha}^{CM} - p\omega_m \psi_{r\beta}^{CM} \right] dt, \quad (7)$$

$$\psi_{r\beta}^{CM} = \int \left[\frac{L_m}{T_r} i_{s\beta} - \frac{1}{T_r} \psi_{r\beta}^{CM} - p\omega_m \psi_{r\alpha}^{CM} \right] dt, \quad (8)$$

$$\psi_{r-CM} = \sqrt{(\psi_{r\alpha}^{CM})^2 + (\psi_{r\beta}^{CM})^2}, \quad (9)$$

Remark 2: *The Integration-controller should use the limitation to remove the drift of DC component on the estimation the rotor flux of the models [19].*

The deviation of the rotor flux between the two models $f(e) = e.i_s$ is corrected through the PI stage to estimate the stator resistance value, as in Eq. (10), Eq. 11.

$$e = (\psi_{r-VM} - \psi_{r-CM}), \quad (10)$$

$$R_{s-est} = K_p.f(e) + K_i \int f(e).dt. \quad (11)$$

The performance of the proposed method is evaluated through the ITAE index for the deviation between the actual and the reference speed during operation time, as in Eq. (12). To minimize the influence of the transient process. The ITAE index will be evaluated during a period corresponding to 6 seconds.

$$ITARE = \int_0^{\tau} t |e_{\omega_m}(t)| dt, \quad (12)$$

With: $e_{\omega_m}(t) = \omega_m - \omega_m^*$

3. Results and Discussion

The performance of the IMD system is simulated corresponding to three cases of stator resistance changes including: ramp function, step function, and multi-ramp function. The three-phase induction motor model is built on the actual motor model corresponding to the basic parameters presented in Appendix A.

The IM is set to increase the ref speed from *zero* to 150 *rpm* (corresponding to 10 of rated speed) in a period of 0.5 *s* and then maintain operation at this speed. Three resistance change cases are investigated with two FOC methods without integration and with an integrated stator resistance estimator for rotor flux angle calculation.

Case 1: The motor's stator resistance is kept at the initial value of 3.179 Ω . At 1.5 *s*, the motor stator resistance increases in a ramp function to a value 20% higher in a period of 0.5 *s*, while the value used to estimate the rotor flux remains the initial value, Fig. 5(a). In the typical FOC method, the determination of the rotor flux angle will be inaccurate, leading to a slight fluctuation in the speed characteristic, Fig. 5(b). The ITAE index determines the deviation between the actual operating speed and the reference speed, which in this case is 0.3225. In the FOC method integrating stator resistance estimation for the voltage model, the stator resistance is estimated following the actual resistance change in the motor, Fig. 5(c). The speed control characteristic of the proposed method operates stably and achieves high efficiency, Fig. 5(d). the ITAE

index is smaller than the typical FOC method, with a value of 0.1150. Evaluation of the speed control efficiency through the ITAE index of the typical FOC and FOC integrated stator resistance methods is shown in Tab. 1.

Tab. 1: ITAE index.

R_s	Typical FOC	Proposed FOC
+10%	0.2481	0.1153
+20%	0.3225	0.1150
+30%	0.3820	0.1168
+40%	0.4211	0.1185
+50%	0.4894	0.1224

Case 2: In reality, when there is current, the stator coil will gradually heat up, leading to a change in resistance according to the material characteristics. However, to test the ability of the proposed method for estimating the stator resistance, a sudden change of the stator resistance as a step function is used to simulate. Similar to case 1, at 1.5 *s*, the stator resistance increases in a step function to a value 20% higher, Fig. 6(a). In a typical FOC method, due to a sudden increase in stator resistance, the rotor flux angle changes suddenly, leading to a strong fluctuation in the speed characteristics before stabilizing again, Fig. 6(b). In the proposed FOC method integrating stator resistance estimation, the value of estimated stator resistance follows the actual resistance change in the motor, Fig. 6(c). The speed control characteristic of the proposed method still keep the stable operating, Fig. 6(d). Because the oscillation during the transient state is high, the ITAE index is not suitable for evaluation in this case.

Case 3: To evaluate the ability of the proposed method's stator resistance estimation function, a multi-ramp change of stator values corresponding to an increase of 10%, 30% and 50% over a period of 0.2 *s* are simulated for performance evaluation, Fig. 7(a). The IMD operates with some slight fluctuation as in Fig. 7(b). In Fig. 7(c), the estimated stator resistance follows the real resistance according to multi-changing. The IMD operates stably throughout operation despite changes in stator resistance of the motor, Fig. 7(d)

4. Conclusion

The FOC method is a popular method in precision motor control, in which accurate estimation of the rotor flux angle plays a decisive role in the performance of the method. This research has proposed a strategy to improve the accuracy of the rotor flux estimation in the voltage model by integrating the stator resistance tuning. Research has shown the effects of stator resistance

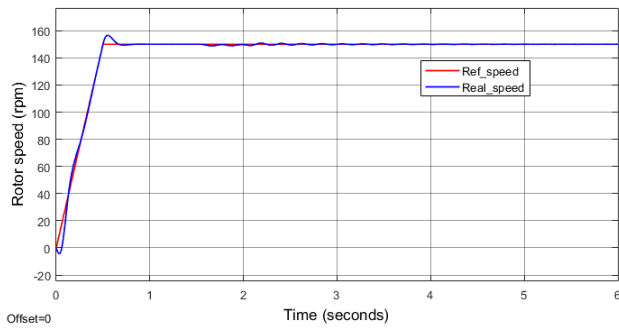

(a) Typical FOC: stator resistances

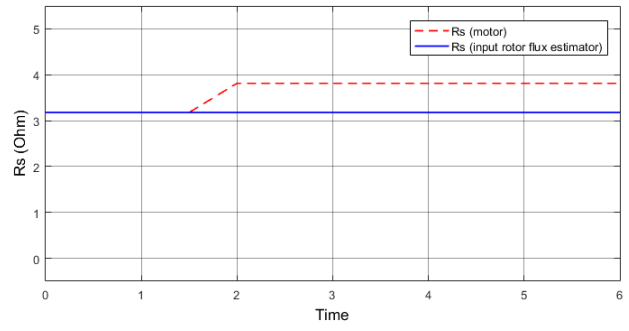

(b) Typical FOC: motor speed

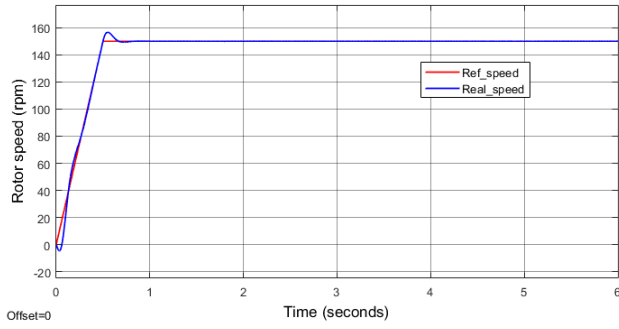

(c) Proposed FOC: stator resistances

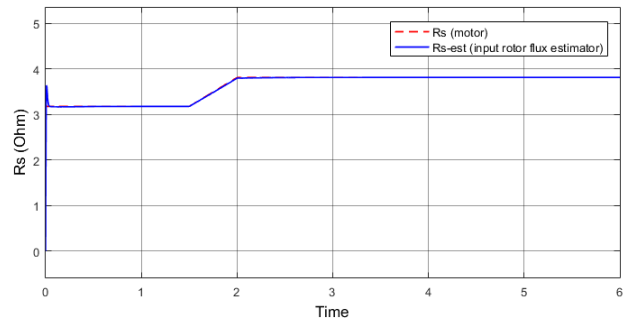

(d) Proposed FOC: motor speed

Fig. 5: Performance of the FOC according to R_s changing as a ramp function.

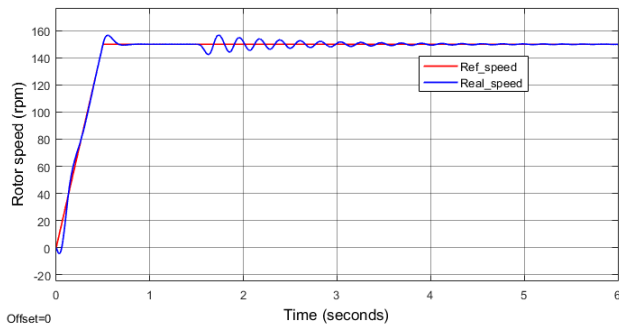

(a) Typical FOC: stator resistances

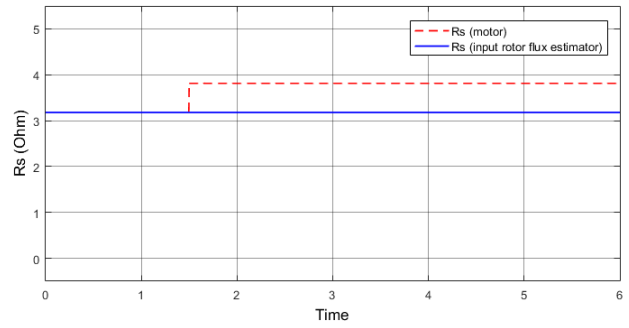

(b) Typical FOC: motor speed

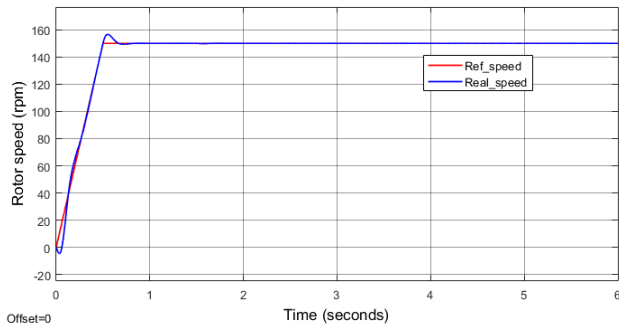

(c) Proposed FOC: stator resistances

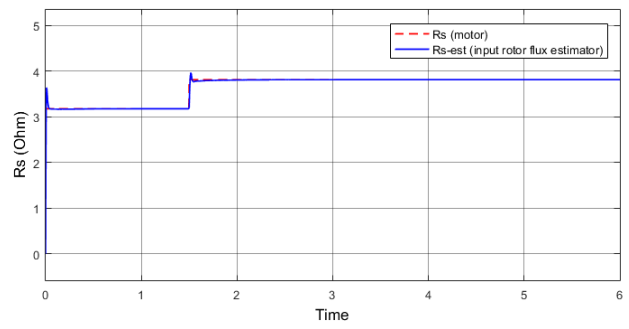

(d) Proposed FOC: motor speed

Fig. 6: Performance of the FOC according to R_s changing as a step function.

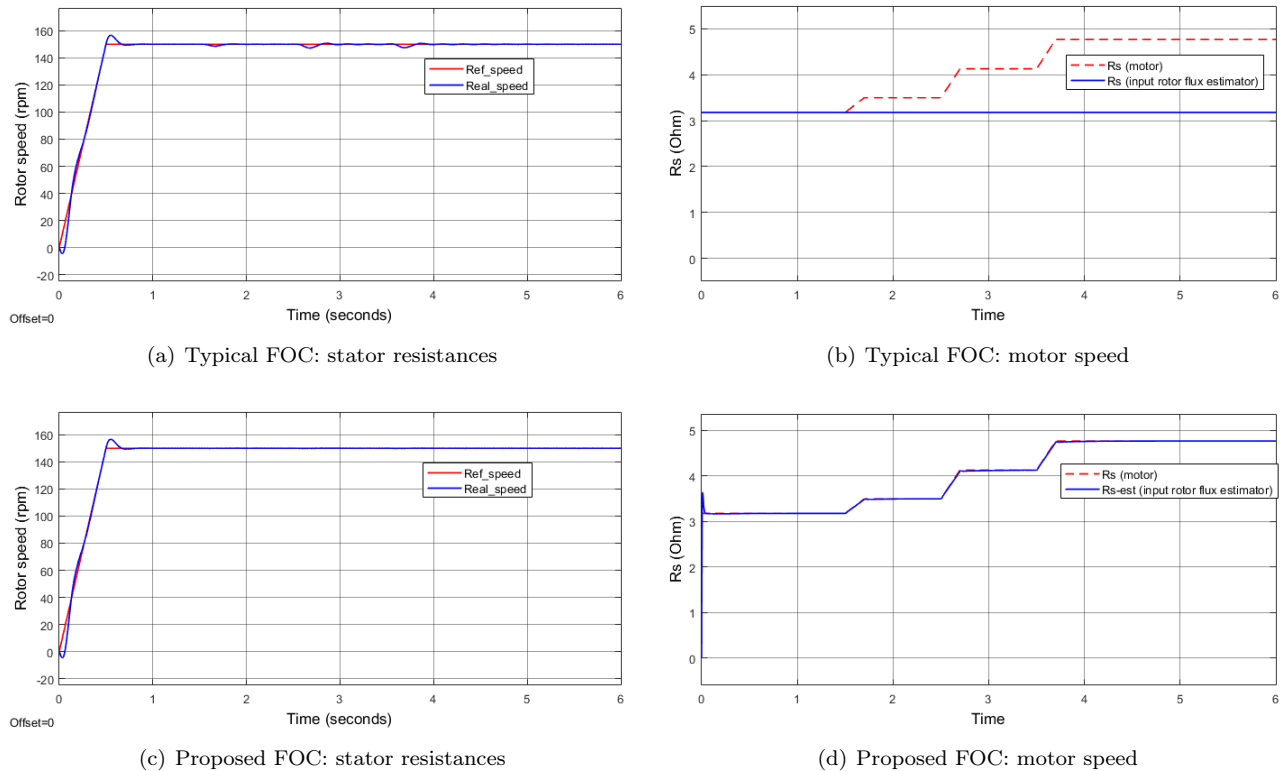

Fig. 7: Performance of the FOC according to R_s changing as multi-ramp functions.

misalignment on the speed characteristics of the IMD. The stator resistance estimation method based on the MRAS technique has demonstrated success through the estimated resistance values following the change in the actual resistance of the motor. And the performance improvement of the proposed FOC method when integrated with stator resistance estimation has been shown in various simulation cases.

Acknowledgment

Authors thank Ton Duc Thang University for supporting this paper.

Author Contributions

Bach Hoang Dinh and Cuong Dinh Tran developed the theoretical formalism, performed the analytic calculations and performed the numerical simulations. Both Bach Hoang Dinh and Cuong Dinh Tran authors contributed to the final version of the manuscript, supervised the project.

References

- [1] ISMAIL, A, A, A., & ELNADY, A. Advanced Drive System for DC Motor Using Multilevel DC/DC Buck Converter Circuit. *IEEE Access*, 2019, vol. 7, pp. 54167-54178. DOI: 10.1109/ACCESS.2019.2912315.
- [2] PURNAMA, H, S., SUTIKNO, T., ALAVANDAR, S., & SUBRATA, A, C. Intelligent Control Strategies for Tuning PID of Speed Control of DC Motor - A Review. *In 2019 IEEE Conference on Energy Conversion (CENCON)*, Yogyakarta, Indonesia, 2019, pp. 24-30. DOI: 10.1109/CENCON47160.2019.8974782.
- [3] DIANOV, A., TINAZZI, F., CALLIGARO, S., & BOLOGNANI, S. Review and Classification of MTPA Control Algorithms for Synchronous Motors. *IEEE Transactions on Power Electronics*, 2022, vol. 37, iss. 4, pp. 3990-4007. DOI: 10.1109/TPEL.2021.3123062.
- [4] YANG, Y., HE, Q., FU, C., LIAO, S., & TAN, P. Efficiency Improvement of Permanent Magnet Synchronous Motor for Electric Vehicles. *Energy*, 2020, vol. 213, pp. 118859. DOI: 10.1016/j.energy.2020.118859.

- [5] CHAN, T, F., & SHI, K. *Applied Intelligent Control of Induction Motor Drives*. John Wiley Sons, 2011, DOI: 10.1002/9780470825587.
- [6] TRAN, C, D., KUCHAR, M., SOBEK, M., SOTOLA, V., & DINH, B, H. Sensor Fault Diagnosis Method Based on Rotor Slip Applied to Induction Motor Drive. *Sensors*, 2022, vol. 22, iss. 22, pp. 8636. DOI: 10.3390/s22228636.
- [7] PEÑA, J, M., & DÍAZ, E, V. Implementation of V/f scalar control for speed regulation of a three-phase induction motor. In *2016 IEEE ANDESCON*, Arequipa, Peru, 2016, pp. 1-4. DOI: 10.1109/ANDESCON.2016.7836196.
- [8] ZHANG, Z., & BAZZI, A, M. Robust sensorless scalar control of induction motor drives with torque capability enhancement at low speeds. In *2019 IEEE International Electric Machines Drives Conference (IEMDC)*, 2019, pp. 1706-1710. DOI: 10.1109/IEMDC.2019.8785159.
- [9] MON-NZONGO, D, L., JIN, T., EKEMB, G., & BITJOKA, L. Decoupling network of field-oriented control in variable-frequency drives. *IEEE Transactions on Industrial Electronics*, 2017, vol. 64, iss. 7, pp. 5746-5750. DOI: 10.1109/TIE.2017.2674614.
- [10] TRAN, C, D., NGUYEN, T, X., & NGUYEN, P, D. A field-oriented control method using the virtual currents for the induction motor drive. *International Journal of Power Electronics and Drive Systems*, 2021, vol. 12, iss. 4, pp. 2095-2102. DOI: 10.11591/ijpeds.v12.i4.pp2095-2102.
- [11] ALEXANDRIDIS, A. T., KONSTANTOPOULOS, G. C., & ZHONG, Q, -C. Advanced Integrated Modeling and Analysis for Adjustable Speed Drives of Induction Motors Operating With Minimum Losses. *IEEE Transactions on Energy Conversion*, 2015, vol. 30, iss. 3, pp. 1237-1246. DOI: 10.1109/TEC.2015.2392256.
- [12] TRAN, C, D., BRANDSTETTER, P., KUCHAR, M., & HO, S, D. (2020). A Novel Speed and Current Sensor Fault-Tolerant Control Based on Estimated Stator Currents in Induction Motor Drives. *International Review of Electrical Engineering*, 2020, vol. 15, iss. 5, pp. 344-351. DOI: 10.15866/iree.v15i5.17937.
- [13] NISHAD, B, K., & SHARMA, R. Induction Motor Control using Modified Indirect Field Oriented Control. In *2018 8th IEEE India International Conference on Power Electronics (IICPE)*, Jaipur, India, 2018, pp. 1-5. DOI: 10.1109/IICPE.2018.8709426.
- [14] NGUYEN, M, C, H., & TRAN, C, D. Improved Sensor Fault-Tolerant Control Technique Applied to Three-Phase Induction Motor Drive. *Indonesian Journal of Electrical Engineering and Informatics (IJEI)*, 2023, vol. 11, iss. 2, pp. 485-493. DOI: 10.52549/ijeei.v11i2.4274.
- [15] LI, W., XU, Z., & ZHANG, Y. Induction motor control system based on FOC algorithm. In *2019 IEEE 8th Joint International Information Technology and Artificial Intelligence Conference (ITAIC)*, Chongqing, China, 2019, pp. 1544-1548. DOI: 10.1109/ITAIC.2019.8785597.
- [16] MA, X., REN, J., ZHAO, L., GE, Q., LI, Y., & ZHAO, Z. Close-loop induction motor rotor flux field-oriented control in single wave voltage feeding. In *2013 International Conference on Electrical Machines and Systems (ICEMS)*, 2013, pp. 2072-2076. DOI: 10.1109/ICEMS.2013.6713171.
- [17] YOUSEF, A, Y., & ABDELMAKSOUND, S, M. Review on Field Oriented Control of Induction Motor. *Int. J. Res. Emerg. Sci. Technol. (IJREST)*, 2015, vol. 2, iss. 7, pp. 5-16.
- [18] KAKODIA, S, K., & DYNAMINA, G. A Comparative Study of DFOC and IFOC for IM Drive. In *2020 First IEEE International Conference on Measurement, Instrumentation, Control and Automation (ICMICA)*, Kurukshetra, India, 2020, pp. 1-5. DOI: 10.1109/ICMICA48462.2020.9242909.
- [19] BRANDSTETTER, P. Sensorless Control of Induction Motor Using Modified MRAS. *International Review of Electrical Engineering*, 2012, vol. 7, iss. 3, pp. 4404-4411. DOI: 10.15598/aece.v11i1.802.
- [20] BRANDSTETTER, P., & DOBROVSKY, M. Speed estimation of induction motor using model reference adaptive system with Kalman filter. *Advances in Electrical and Electronic Engineering*, 2013, vol. 11, iss. 1, pp. 22-28. DOI: 10.15598/aece.v11i1.802.
- [21] VO, H, H., KUCHAR, M., & BRANDSTETTER, P. Application of fuzzy logic in sensorless induction motor drive with PWM-DTC. *Electr Eng*, 2020, vol. 102, pp. 129-140. DOI: 10.1007/s00202-019-00810-z.
- [22] BANERJEE, T., BERA, J, N., CHOWDHURI, S., & SARKAR, G. A comparative study between different modulations techniques used in field-oriented control induction motor drive. In *2016 2nd International Conference on Control, Instrumentation, Energy Communication (CIEC)*, Kolkata, India, 2016, pp. 358-362. DOI: 10.1109/CIEC.2016.7513777.

- [23] WANG, Y., SHI, Y., XU, Y., & LORENZ, R. D. A comparative overview of indirect field oriented control (IFOC) and deadbeat-direct torque and flux control (DB-DTFC) for AC Motor Drives. *Chinese Journal of Electrical Engineering*, 2015, vol. 1, iss. 1, pp. 9-20. DOI: 10.23919/CJEE.2015.7933134.
- [24] D. Perduková, P. Palacký, P. Fedor, P. Bober and V. Fedák, "Dynamic Identification of Rotor Magnetic Flux, Torque and Rotor Resistance of Induction Motor," *IEEE Access*, vol. 8, pp. 142003-142015, 2020, DOI: 10.1109/ACCESS.2020.3013944.
- [25] ADAMCZYK, M. Rotor resistance estimator based on virtual current sensor algorithm for induction motor drives. *Power Electronics and Drives*, 2020, vol. 5, iss. 1, pp. 143-156. DOI: 10.2478/pead-2020-0008.
- [26] KHAN, Y, A., & VERMA, V. Stator resistance estimation for MRAS-based speed sensorless vector-controlled switched reluctance motor drive. *Electr Eng*, 2021, vol. 103, pp. 1949-1963. DOI: 10.1007/s00202-020-01203-3.
- [27] VAZIFEDAN, M., & ZARCHI, H, A. A Stator Resistance Estimation Algorithm For Sensorless Dual Stator Winding Induction Machine Drive Using Model Reference Adaptive System. *In 2020 11th Power Electronics, Drive Systems, and Technologies Conference (PEDSTC)*, Tehran, Iran, 2020, pp. 1-7. DOI: 10.1109/PEDSTC49159.2020.9088399.
- [28] JO, G, -J., & CHOI, J, -W. Gopinath ModelBased Voltage Model Flux Observer Design for Field-Oriented Control of Induction Motor. *IEEE Transactions on Power Electronics*, 2019, vol. 34, iss. 5, pp. 4581-4592. DOI: 10.1109/TPEL.2018.2864322.
- [29] SHUAIB, A, O., & AHMED, M, M. (2014). Robust PID control system design using ITAE performance index (DC motor model). *International Journal of Innovative Research in Science, Engineering and Technology*, 2014, vol. 3, iss. 8, pp. 15060-15067, DOI: 10.15680/IJRSET.2014.0308002.
- [30] RAHMAN, T., MOTAKABBER, S, M, A., & IBRAHIMY, M. I. Design of a Switching Mode Three Phase Inverter. *In 2016 International Conference on Computer and Communication Engineering (ICCCE)*, Kuala Lumpur, Malaysia, 2016, pp. 155-160. DOI: 10.1109/ICCCE.2016.43.

About Authors

Bach Hoang DINH is the head of the Electrical Engineering Department, Faculty of Electrical-Electronic Engineering at Ton Duc Thang University. He received B.E., M.E degrees from Vietnam National UniversityHochi Minh City and Ph.D. degree from Heriot-Watt University, Edinburgh, the United Kingdom, in 1995, 1998, and 2009. His research interests are intelligent and optimal control, computer vision, robotics, power electronics, SCADA, and industrial communication networks. He is a member of the IEEE Industrial Electronics Society. He can be contacted at email: dinhhoangbach@tdtu.edu.vn

Cuong Dinh TRAN (corresponding author) is a lecturer in the Faculty of Electrical-Electronic Engineering at Ton Duc Thang University. He received his BE, and ME degrees from Ho Chi Minh City University Of Technology, Vietnam, and his Ph.D. from the VSB-Technical University of Ostrava, the Czech Republic, in 2005, 2008, and 2020. His research interests include modern control methods and intelligent algorithms in motor drives. He can be contacted at email: trandinhcuong@tdtu.edu.vn

Appendix A The Basic Machine Parameters

- Resistances: stator/rotor – 3.179/2.118 Ω ,
- Inductances: stator/rotor – 0.209/0.209 H ,
- Inductances magnetizing – 0.192 H ,
- Rated voltage: 380 V ,
- Rated current: 4.85 A ,
- Rated speed: 1420 rpm ,
- Rated torque: 14.8 N .